



NORTH BIHAR POWER DISTRIBUTION CO. LTD., PATNA

(Registered Office, Vidyut Bhawan, Bailey Road, Patna)

(Department of Rural Electrification)

Letter No.- N-XII/RGGVY/GTP & Drawing/Samastipur-1317/2015-

Date-

E-mail-cere.bseb@gmail.com

From,

S.K. Sriastava
Chief Engineer (Project-I)

To,

M/s Ashoka Buildcom Ltd
Ashoka house, Ashoka Marg,
Ashoka Nagar, Wadala Shiwar
Nasik-422011

Sub:-

Regarding approved GTP, Drawing of M/s Rajesh Electricals, Kolkata

Ref:-

Your letter no.-ABL/PWR/RGGVY/Samastipur/200516/2486 dated 20.05.2016

Sir,

Please find enclosed herewith approved GTP/Drawing of following Items submitted by you vide letter under reference as per REC/TS, 12th Plan RGGVY work and valid type test report for Samastipur District.

S.N.	Material Description	Vendor Name
1	Suspension Clamp for messenger wire	M/s Rajesh Electricals, 22, Rabindra Sarani, Kolkata-700073
2	Insulating Piercing Connector	
3	Coil Earthing	
4	Earthing Pipe	
5	Dead End Clamp with Eye Hook	
6	11/33 KV Danger Board	
7	33 KV 630A AB Switch	

It may please be noted that approval of GTP/Drawing of subject material does not absolve you of contractual responsibility in terms of its quality etc. In case any problem/ issue with regard to material/vendor arises at any stage, NBPDCCL reserves the right of withdrawal of this approval as well as ask the turnkey contractor to replace the materials at their own cost immediately.

Encl:- As above

Yours faithfully

Sd/-

(S.K. Srivastava)

Chief Engineer (Project-I)

Memo No.-

Date-

Copy with a copy of approved GTP, Drawing forwarded to ESE, Electric Supply Circle, Samastipur/EEE (Project), Electric Supply Division Samastipur for information and necessary action.

Encl:-As above

Sd/-

(S.K. Srivastava)

Chief Engineer (Project-I)

Memo No.- 3907

Date- 30-6-16

Copy forwarded to All EEEs (Project-I)/Electrical Executive Engineer (IT), North Bihar Power Distribution Company Limited to upload this information and GTP & Drawing on NBPDCCL website.

Encl:-As above

(S.K. Srivastava)

Chief Engineer (Project-I)

Contractor	ASHOKA BUILDCON LIMITED
Client	North Bihar Power Distribution Company Limited, Bihar (NBPDC)
NIT NO.	(A) 157/PR/NBPDC/2014 (B) 158/PR/NBPDC/2014
LOA Detail	(A) 2757 & 2758 XIII/RE/NIT No-157/14/Samastipur-1415/14/21.08.2014 (B) 2759 & 2760 XIII/RE/NIT No-158/14/Paschim Champaran-1416/14/21.08.2014
Manufacturer	RAJESH ELECTRICALS, KOLKATA

**GUARANTEED TECHNICAL PARTICULARS FOR
SUSPENSION CLAMP FOR MESSENGER WIRE**

1	NAME OF MANUFACTURER	RAJESH ELECTRICALS 22, RABINDRA SARANI, KOLKATA - 700 073
2	ARE DRAWINGS ENCLOSED	YES ✓
3	RANGE	MESSENGER WIRE 16 - 95 ✓
4	MATERIALS	a) CLAMP BODY & PRESSURE PAD : ALUMINIUM ALLOY, GRADE- LM6 b) BASE COVER: UV STABILISED THERMOPLASTIC
5	DIMENSION OF CLAMP	PLEASE REFER DRAWING
6	NO OF BOLTS & WASHER	ONE BOLT ALONG WITH ONE FLAT ROUND WASHER
7	PARTICULARS OF GALVANISATION	BOLT HOT DIP GALVANISED TO IS 1367 PART 13/BS-729 FLAT ROUND WASHER : ELECTRO ZINC PLATED TO IS : 1573 (ACCORDING TO CLASSIFICATION NO FE/ZN 5)
8	TENSION LOAD	15 KN ✓
9	ACCEPTANCE TEST	a) DIMENSIONAL CHECK AS PER DRAWING

Conforming to T.S of RGGVY 12th plan. In Case of variation in approved, GTP & T.S, RGGVY T.S will be preferred.

Checked

[Signature]
AEE(RE)

[Signature]
EEE(RE)

ESE(RE)

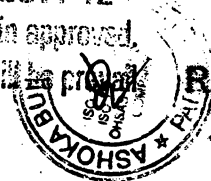

RAJESH ELECTRICALS

[Signature]
Proprietor

Approved

[Signature]
CE (Project-I)
NBPDC, Patna

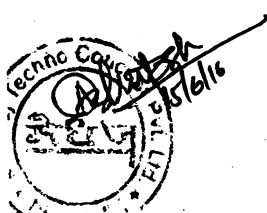

SUSPENSION CLAMP - FOR BARE MASSEGER CABLE - FOR SUPPORTING MASSEGER CABLE

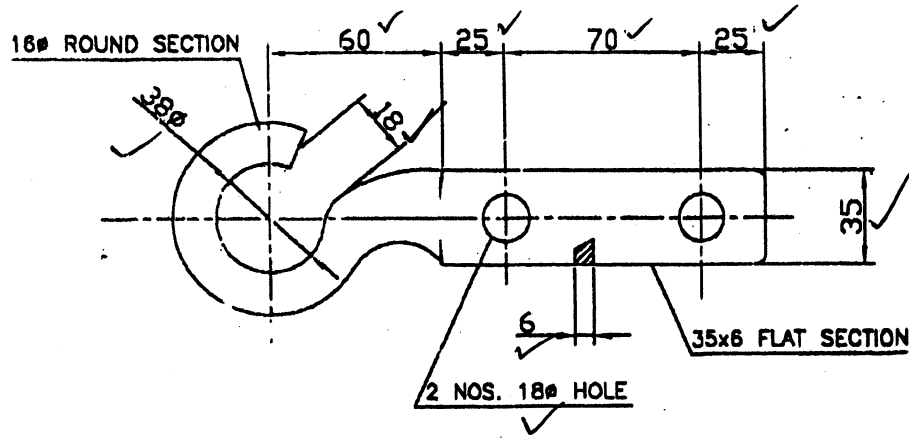

EYE HOOK

-Conforming to T.S of RGGVY 12th plan. In Case of variation in approved. GTP & T.S, RGGVY T.S will be prevail

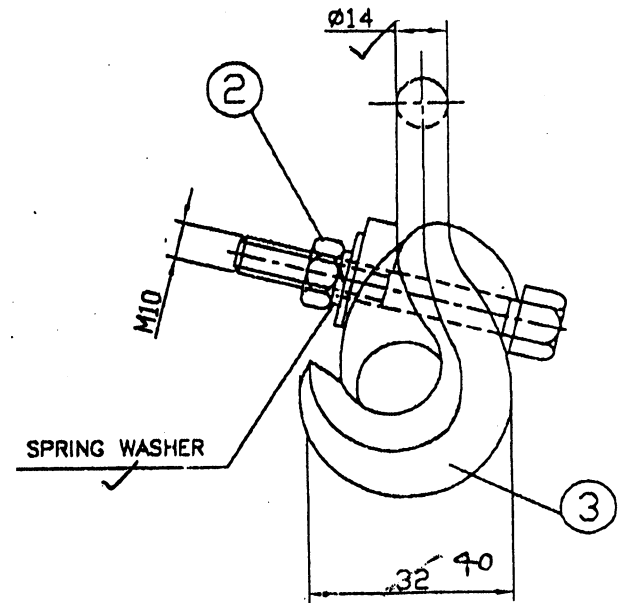
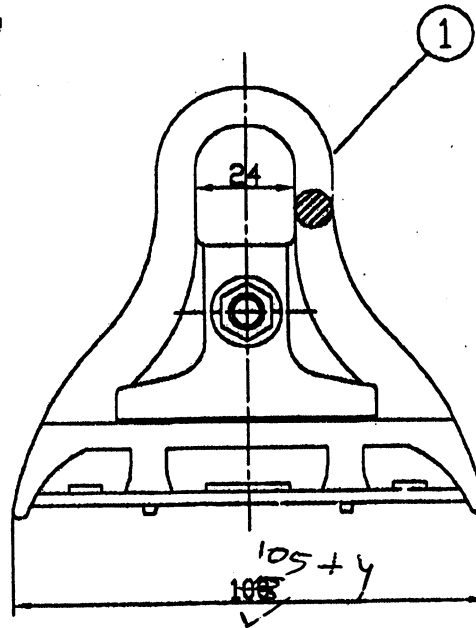

SL.NO.	BARE MASSEGER SIZE RANGE	
	(MM. ²)	DIA.(MM)
1	16-120	14

Checked

SUSPENSION CLAMP

Approved

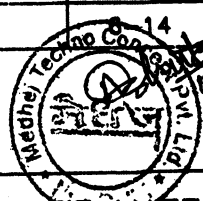

ESE(RE)

 EEE(RE)

CE (Project-I)
NBPDC, Patna

BILL OF MATERIALS

SL.NO.	DESCRIPTION	MATERIAL	QTY
3	PLASTIC COVER	PVC	1
2	BOLT. NUT. PLAIN & SPRING WASHER	M.S. HDG & SP. ST. EG	1
1	BODY & KEEPER	ALUMINIUM ALLOY	1

REV.	DATE	REV. DESCRIPTION	U.T.S.	TENDR ORDER
			STANDERED	
<p align="center">RAJESH ELECTRICALS 22 RABINDRA SARANI KOLKATA - 73 [W.B.]</p>				UNIT: mm
SCALE: NT\$				DRAWN: S.DEY
DATE: 06.06.06				CHECKED:
SUSPENSION CLAMP FOR BARE MASSEGER CABLES				APPROVED:
				DRG.NO: RE/121



Contractor	ASHOKA BUILDCON LIMITED
Client	North Bihar Power Distribution Company Limited, Bihar (NBPDC)
NIT NO.	(A) 157/PR/NBPDC/2014 (B) 158/PR/NBPDC/2014
LOA Detail	(A) 2757 & 2758 XIII/RE/NIT No-157/14/Samastipur-1415/14/21.08.2014 (B) 2759 & 2760 XIII/RE/NIT No-158/14/Paschim Champaran-1416/14/21.08.2014
Manufacturer	RAJESH ELECTRICALS, KOLKATA

**GUARANTEED TECHNICAL PARTICULARS FOR
INSULATING PIERCING CONNECTOR**

SL. No.	Description	Offered Value
1	NAME & ADDRESS OF MANUFACTURER	RAJESH ELECTRICALS , 22 RABINDRA SARANI KOLKATA – 700073
2	APPLICABLE STANDARD	RELEVANT IS SPECIFICATION
3	TYPE OF CONNECTORS MAIN	16 to 95 SQ. MM
4	APPLICATION	FOR AB Cable.
5	IS ANY METALLIC PART CARRYING POTENTIAL IN OPERATION EXPOSED DURING INSTALLATION	YES

Conforming to T.S of RGGVY 12th plan. In Case of variation in approved. GTP & T.S, RGGVY T.S will be prevail



RAJESH ELECTRICALS

Handwritten signature

Proprietor

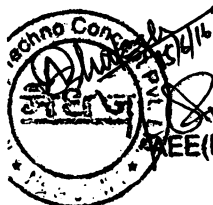

Checked

19.6.16
EEE(RE) EEE(RE) ESE(RE)

Approved

Handwritten signature
CE (Project-I)
NBPDC, Patna

INSULATION PIERCING CONNECTORS (IPC) OR TEE- OFF

CONNECTORS FOR ABC Cables- for branch making for Overhead distribution and services with bundle assembled cores, of rated voltage 0.6/1 KV.

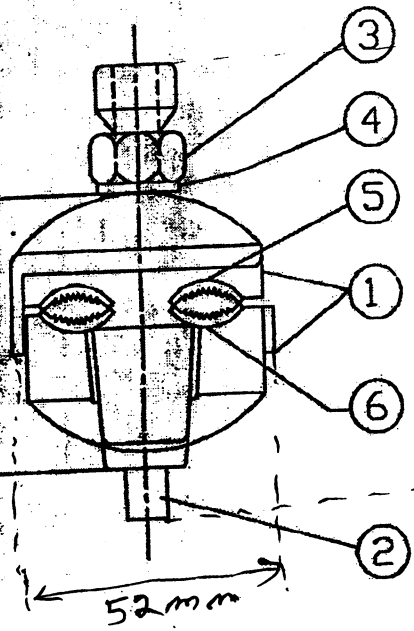

85 mm

Esd - 43 mm

SIZE = 85 X 52 X 43 mm

Conforming to T.S of RGGVY 12th plan. In Case of variation in approved. GTP & T.S, RGGVY T.S will be prevail

SL. NO.	CABLE SIZE IN SQ.mm.	
	MAIN	TAP
1	16-95	2.5-16
2	16-95	16-50

Checked

Approved

(Signature) 12.6.16
 AEE(RE) EEE(RE) ESE(RE)

(Signature)
 CE (Project-I)
 NBPDCI, Patna

SL. NO.	DESCRIPTION	MATERIAL	QTY.
7	TOP CABLE CAP	PVC/EPDM	1
6	PIERCING PLATE	ALLUMINIUM ALLOY	1
5	WATER TIGHTNESS	PVC/EPDM	1
4	PLAIN WASHER	MILD STEEL H.D.G.	1
3	OVERTORQUE NUT	THERMOPLASTIC	1
2	M8 BOLT & NUT	MILD STEEL H.D.G.	1 EACH
1	BODY	THERMOPLASTIC	1 SET

NOTES :

GENERAL TOLERANCE : 5% ON INDICATED DIMENSIONS ONLY

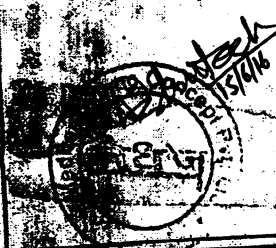

REV	REV/DESCRIPTION	TOLERANCE	UNIT
		± 0.1	MM
RAJESH ELECTRICALS			
22, RAJINDRA SARANI TREETTA BAZAR, SHOP NO. 234/235, KOLKATA - 700 073 [W.B.] PHONE : (0) 2238-5369.			
SCALE = N.T.S	INSULATION PIERCING CONNECTOR		DRG. NO: RE/123
DATE = 14.06.06			
		DRAWN	S. DEY
		CHECKED	R. SHINA
		APPROVED	



80

Contractor	ASHOKA BUILDCON LIMITED
Client	North Bihar Power Distribution Company Limited, Bihar (NBPDC)
NIT NO.	(A) 157/PR/NBPDC/2014 (B) 158/PR/NBPDC/2014
LOA Detail	(A) 2757 & 2758 XIII/RE/NIT No-157/14/Samastipur- 1415/14/21.08.2014 (B) 2759 & 2760 XIII/RE/NIT No-158/14/Paschim Champaran- 1416/14/21.08.2014
Manufacturer	RAJESH ELECTRICALS, KOLKATA

GUARANTEE TECHNICAL PARTICULARS FOR COIL EARTHING

1. All dimensions are in mm. otherwise specified.
2. Earthing rod dia 8 SWG. ✓
3. Earthing spiral 50 x 450 ✓
4. Spiral earth wire 8 SWG G.I. Closely round 115 turns. ✓
5. General Tolerance ± 5% ✓

b. weight of coil :- 1.85 kg

ITEM NO.	DESCRIPTION	MATERIAL	QUANTITY
01	Earth coil : 8 Swg. Wire & 115 nos. (Turn) coil	G. I.	1 No.



Conforming to T.S of RGGVY 12th plan. In Case of variation in approved. GTP & T.S, RGGVY T.S will be prevail.

RAJESH ELECTRICALS

Signature
Proprietor

Checked

Signature 17.6.16
AEE(RE) *Signature* 17/06
EEE(RE) ESE(RE)

Approved

Signature
CE (Project-I)
NBPDC, Patna



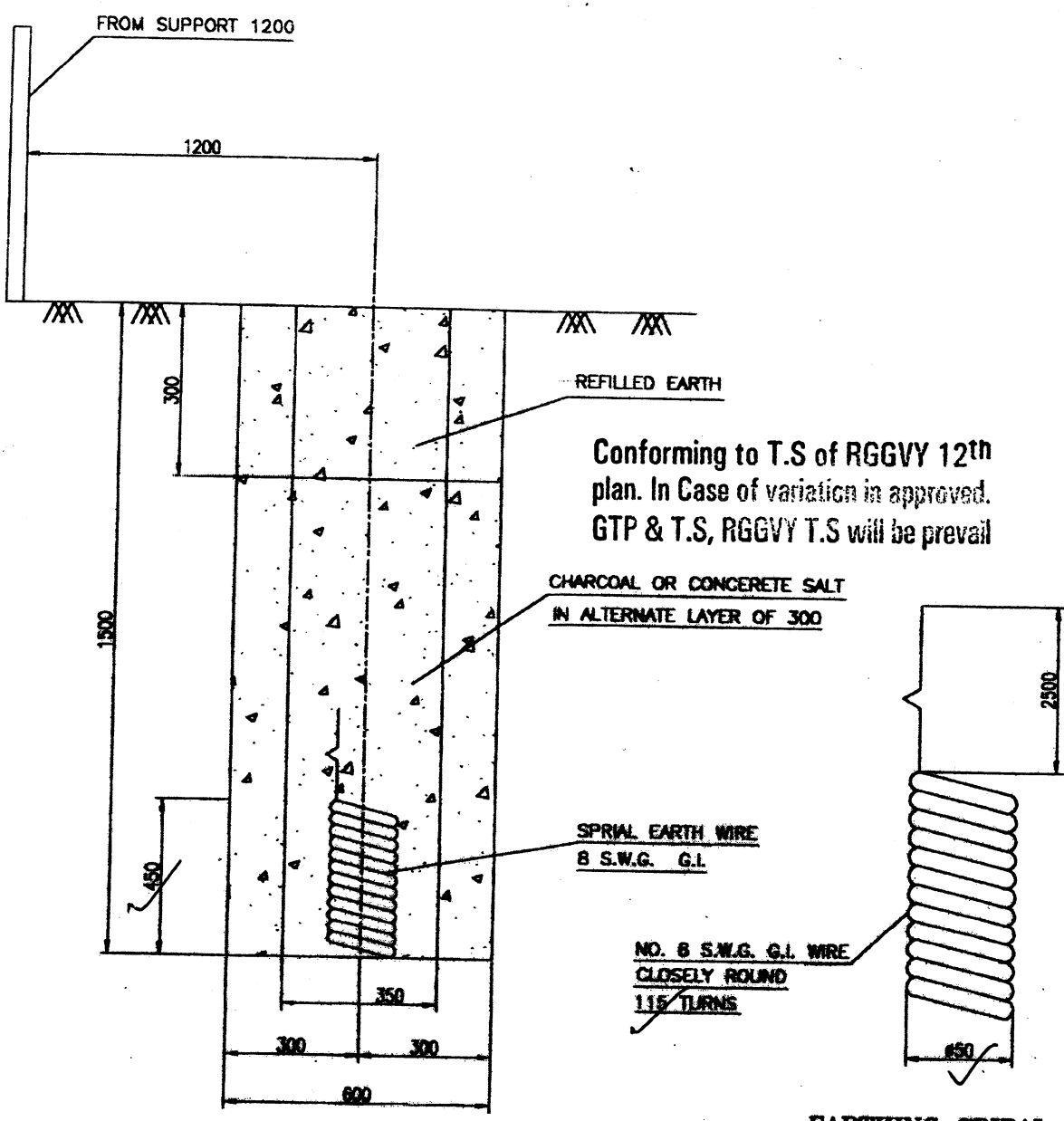

Conforming to T.S of RGGVY 12th plan. In Case of variation in approved. GTP & T.S, RGGVY T.S will be prevail

CHARCOAL OR CONCRETE SALT IN ALTERNATE LAYER OF 300

SPIRAL EARTH WIRE 8 S.W.G. G.I.

NO. 8 S.W.G. G.I. WIRE CLOSELY ROUND 115 TURNS

EARTHING SPIRAL

Checked COIL EARTHING

Approved

17.6.16
 EEE(RE)
 EEE(RE)
 ESE(RE)

CE (Project-I)
 NBPDCI, Patna

PROJECT : RURAL ELECTRIFICATION.

CONTRACTOR :

REV	DATE	REV/DESCRIPTION	TOLERANCE ±3%	STANDARD IS: 8541	TENDER ORDER
<p>RAJESH ELECTRICALS 22, RABINDRA SARANI TIRETTA BAZAR, SHOP NO. 234/235. KOLKATA - 700 073 [W.B.] PHONE : (0) 2236-5369.</p>					LIST: DRAWN: S. DEY CHECKED: R. SHINA APPROVED:
SCALE = N.T.S			<p><u>COIL EARTHING</u></p>		DRG.NO: RE/151
DATE : 06.02.07					

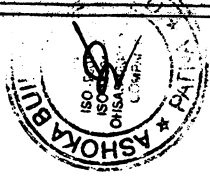

78



Contractor	ASHOKA BUILDCON LIMITED
Client	North Bihar Power Distribution Company Limited, Bihar (NBPDC)
NIT NO.	(A) 157/PR/NBPDC/2014 (B) 158/PR/NBPDC/2014
LOA Detail	(A) 2757 & 2758 XIII/RE/NIT No-157/14/Samastipur-1415/14/21.08.2014 (B) 2759 & 2760 XIII/RE/NIT No-158/14/Paschim Champaran-1416/14/21.08.2014
Manufacturer	RAJESH ELECTRICALS, KOLKATA

GUARANTEED TECHNICAL PARTICULARS FOR EARTHING PIPE

SL. No.	Description	Offered Value
1	NAME & ADDRESS OF MANUFACTURER	RAJESH ELECTRICALS, 22 RABINDRA SARANI KOLKATA - 700073
2	STANDARD TO WHICH MATERIALS CONFORMS	AS PER REC SPECIFICATION
3	SUITABLE FOR	EARTHING
4	MATERIAL USED TO MANUFACTURE	M S PIPE ✓
5	METHOD OF FIXING CLAMP	WELDING
6	LENGTH OF PIPE	3000 MM ✓
7	DIAMETER OF PIPE	40 MM ✓
8	CLAMP	40 X 3 50 X 6 mm GI FLAT ✓
9	APPROX WEIGHT OF TOTAL MATERIAL	7.5 KGS (APPROX)
10	SIZE OF HOLE IN PIPE SECTION	12 MM DIA HOLE ✓
11	SIZE OF HOLE IN CLAMP SECTION	18 18 MM Required
12	TOLERANCE	+/- 5%

Conforming to T.S of RGGVY 12th plan. In Case of variation in approved. GTP & T.S, RGGVY T.S will be prevail

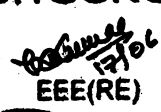
Checked

 AEE(RE)
 EEE(RE)
 BSE(RE)

 Techno Concept
 15/6/16

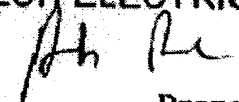

RAJESH ELECTRICALS

 Proprietor

Approved

 CE (Project-I)
 NBPDC, Patna